



CERTIFICATE OF MAILING

I hereby certify that this correspondence is being deposited with the United States Post Office as first class mail in an envelope addressed to: Commissioner for Patents, Washington, D.C. 20231, on

Date: 11-28-01
Name: Melissa Spanzillo
Signature: Melissa Spanzillo
Clifford Chance Rogers & Wells LLP

Docket No. 6175-015

IN THE UNITED STATES PATENT AND TRADEMARK OFFICE

In re Application of: Lee et al.

Filed: August 8, 2001 Group Art Unit: 2122

Serial No: 09/924,294 Examiner: to be determined

For: AUTOMATED THREE-DIMENSIONAL ALTERNATIVE POSITION
VIEWER

SUBMISSION OF FORMAL DRAWINGS

Commissioner for Patents
Attn: Official Draftperson
Washington, D.C. 20231

Sir:

In response to the Notice to File Missing Parts of NonProvisional Application mailed on September 25, 2001 (copy enclosed), enclosed please find Formal Drawings illustrating Figs. 1-15 (15 sheets) for the above-identified application and which replace the corresponding originally submitted drawings. No new matter has been added.

It is respectfully requested that these drawings be approved by the Official Draftsperson and made of record in the file of this case.

FOR THE "PATENT" FILE

The Commissioner is hereby authorized to charge any additional fees which may be required in connection with this request, or to credit any overpayment to Deposit Account No. 50-0521. A duplicate copy of this transmittal is enclosed.

Respectfully submitted,

Date: Nov 26, 2007

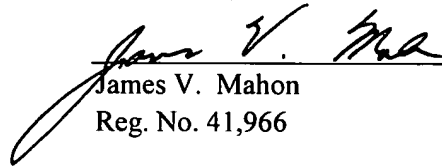

James V. Mahon
Reg. No. 41,966

Clifford Chance Rogers & Wells LLP
200 Park Avenue
New York, NY 10166-0153
Telephone: (212) 878-8073

09024294-12034
"FOREF" 4624260

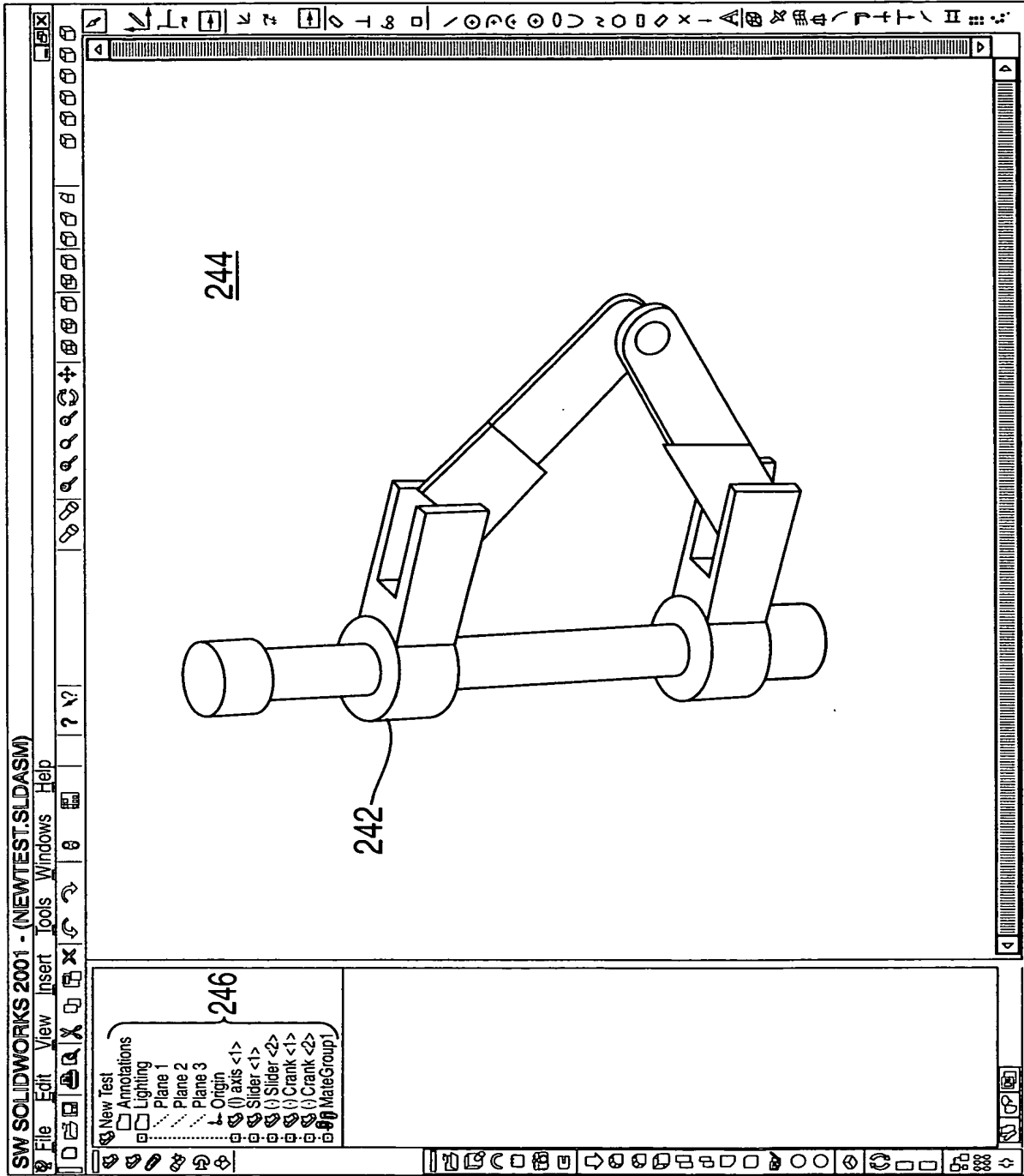

FIG. 3
CLASSIFICATION

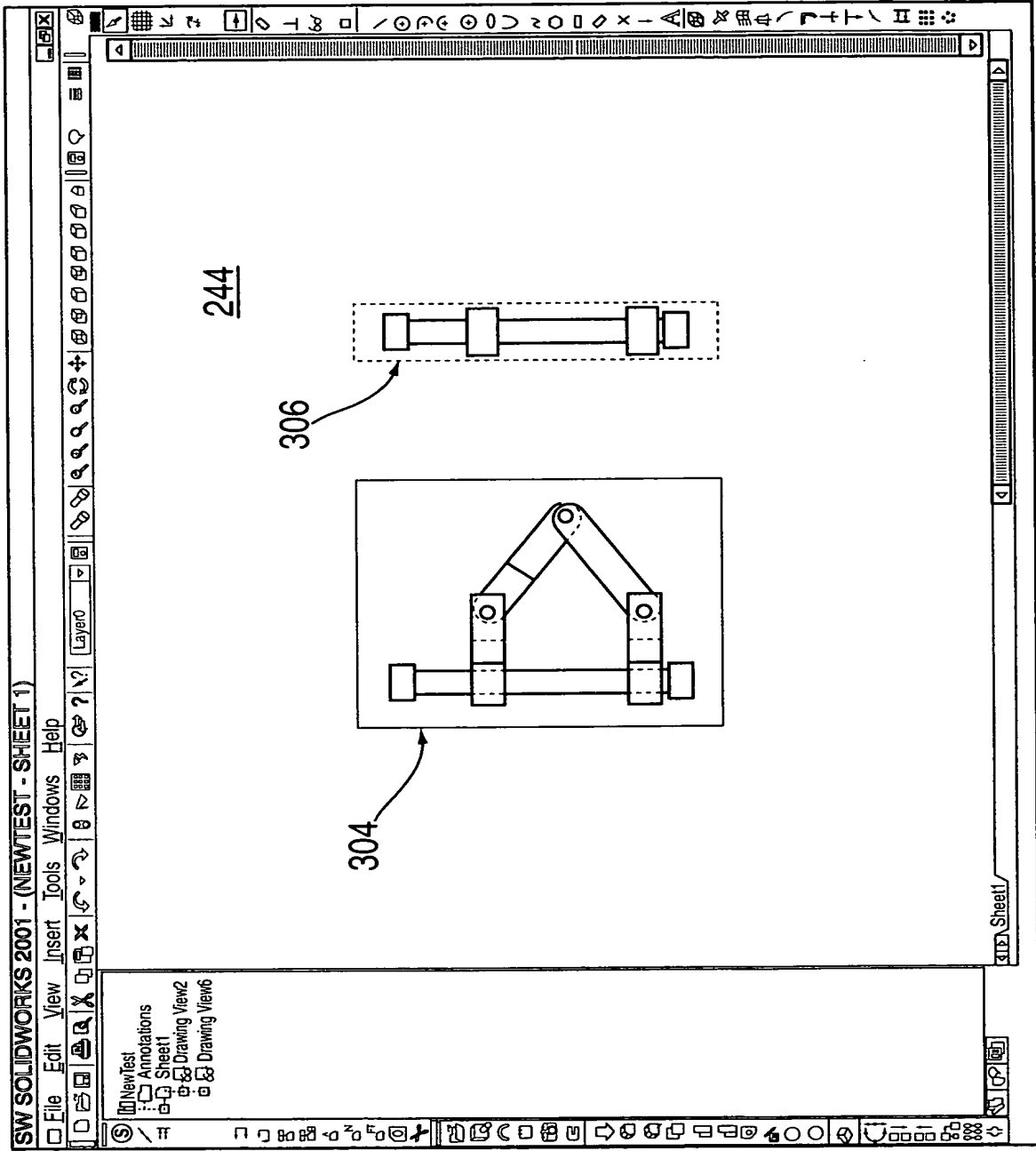

FIG. 3

FIG. 4

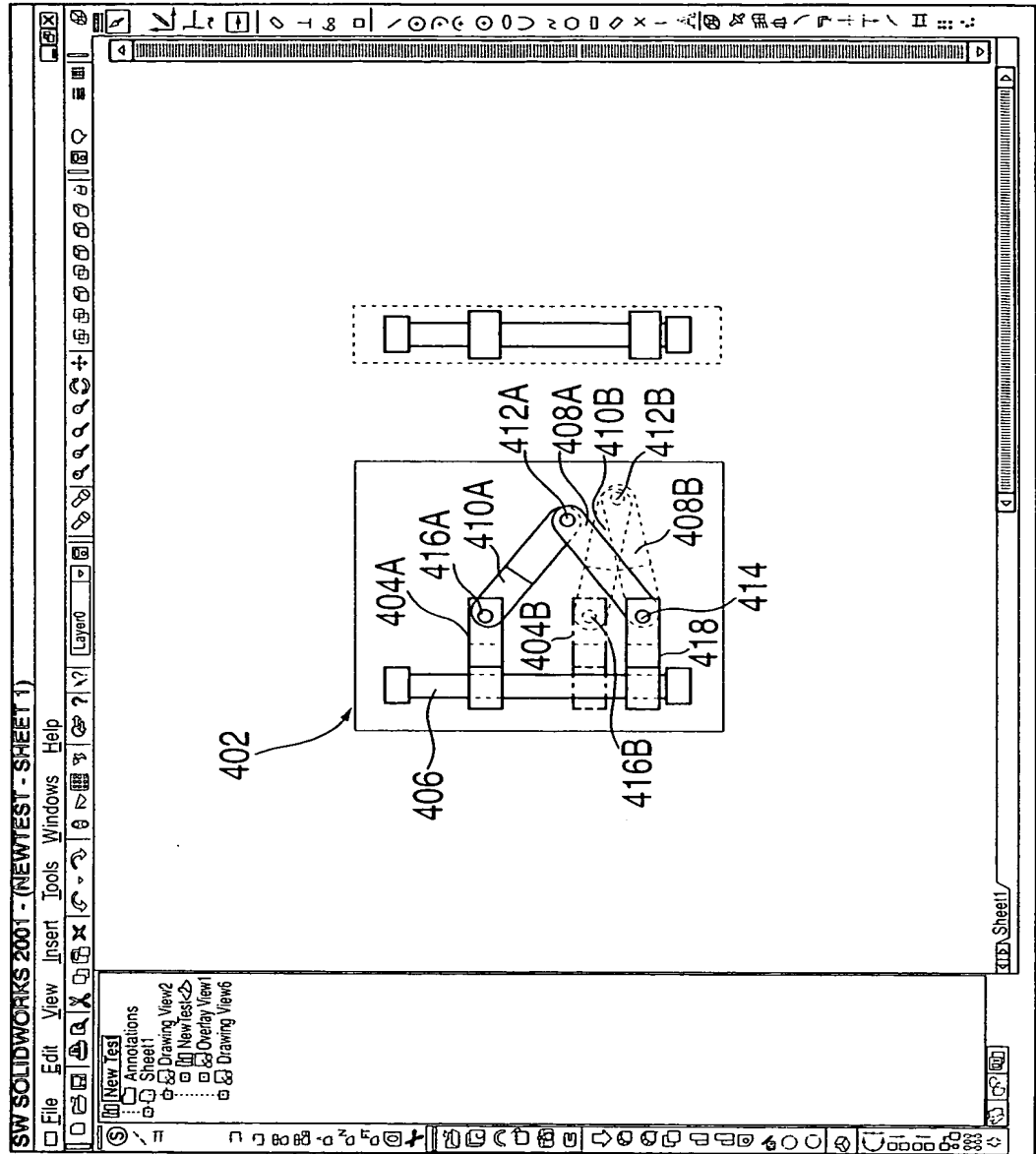

FIG. 4

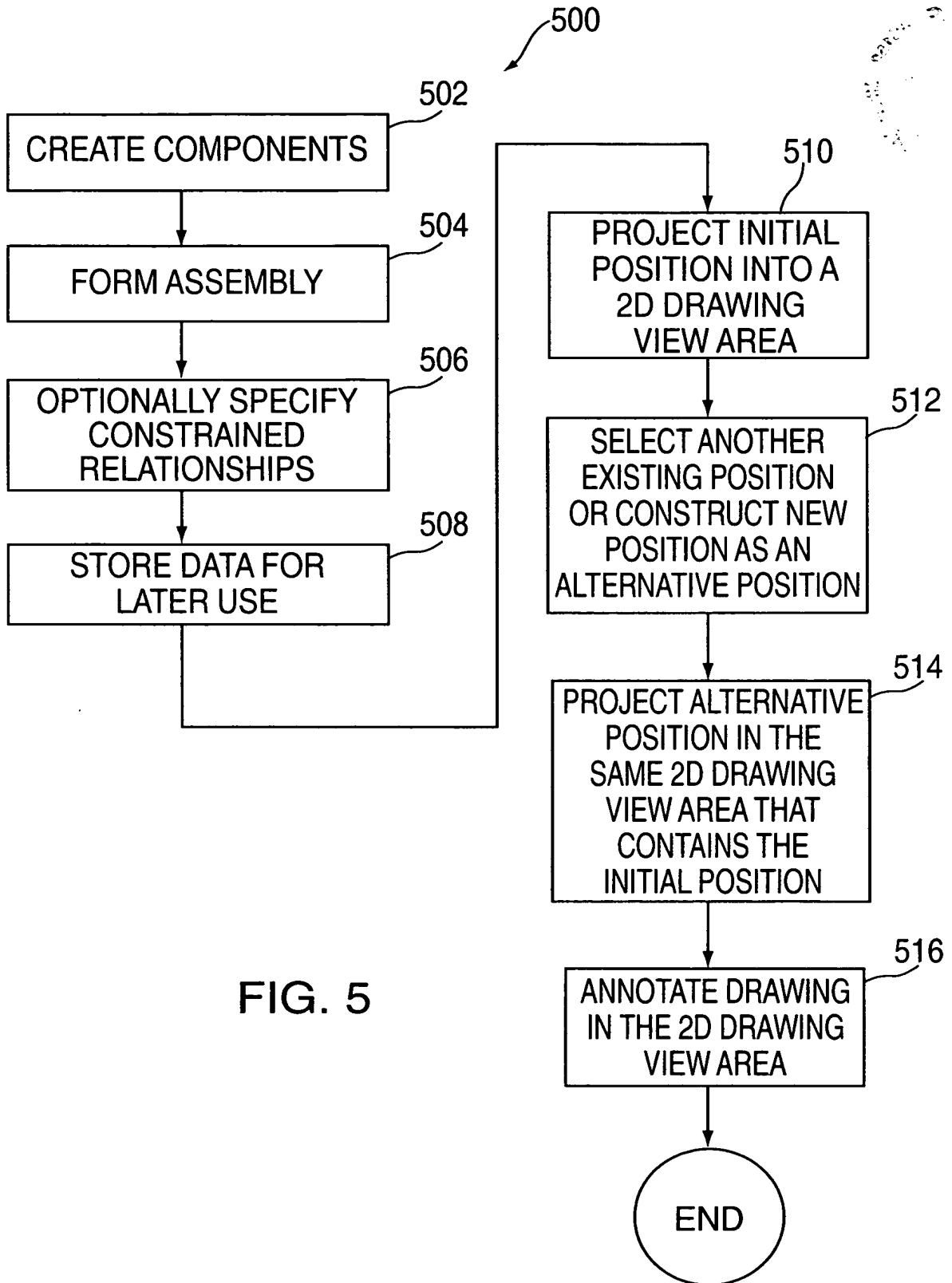

FIG. 5

099494 120394

FIG. 6

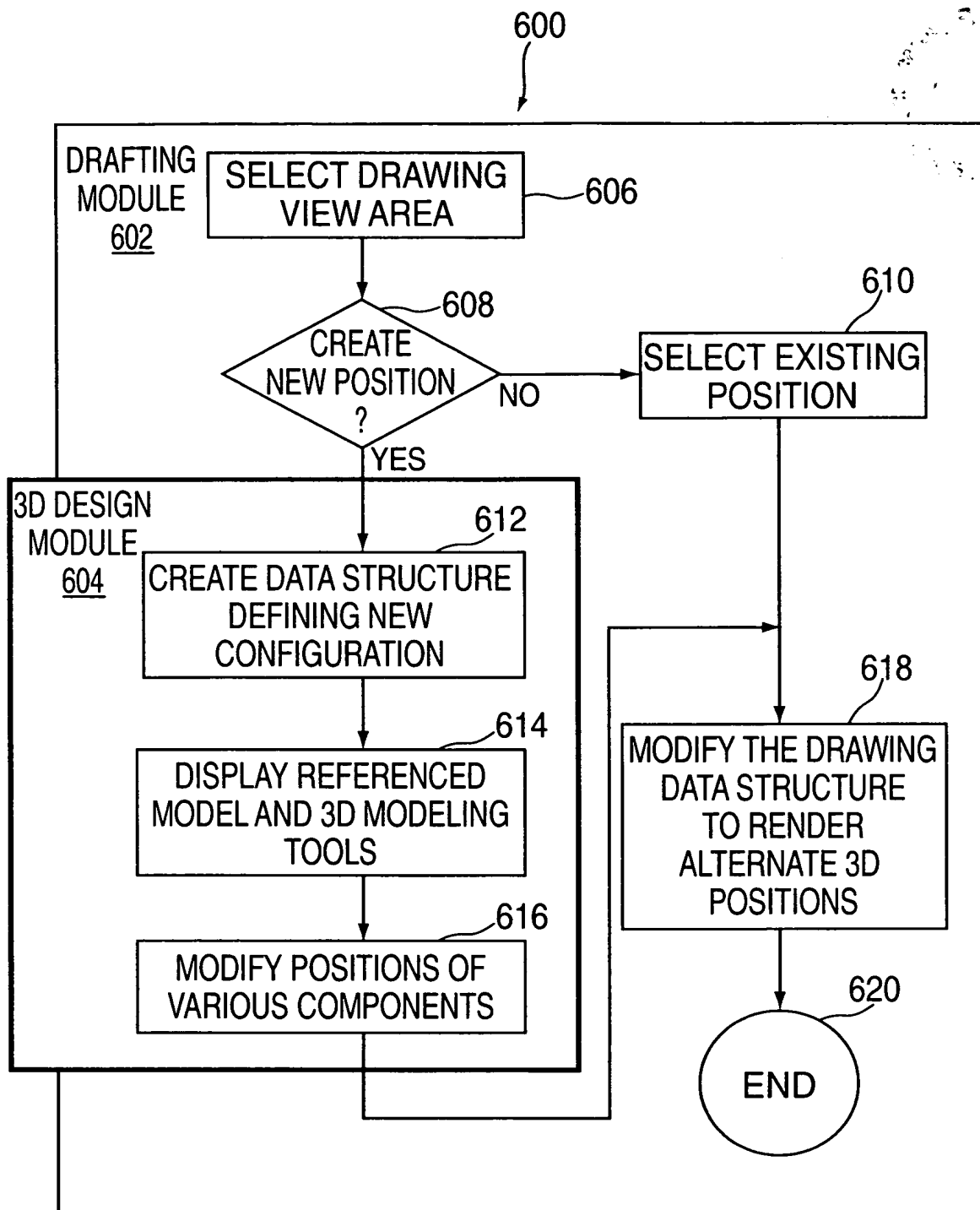

FIG. 6

FIG. 7

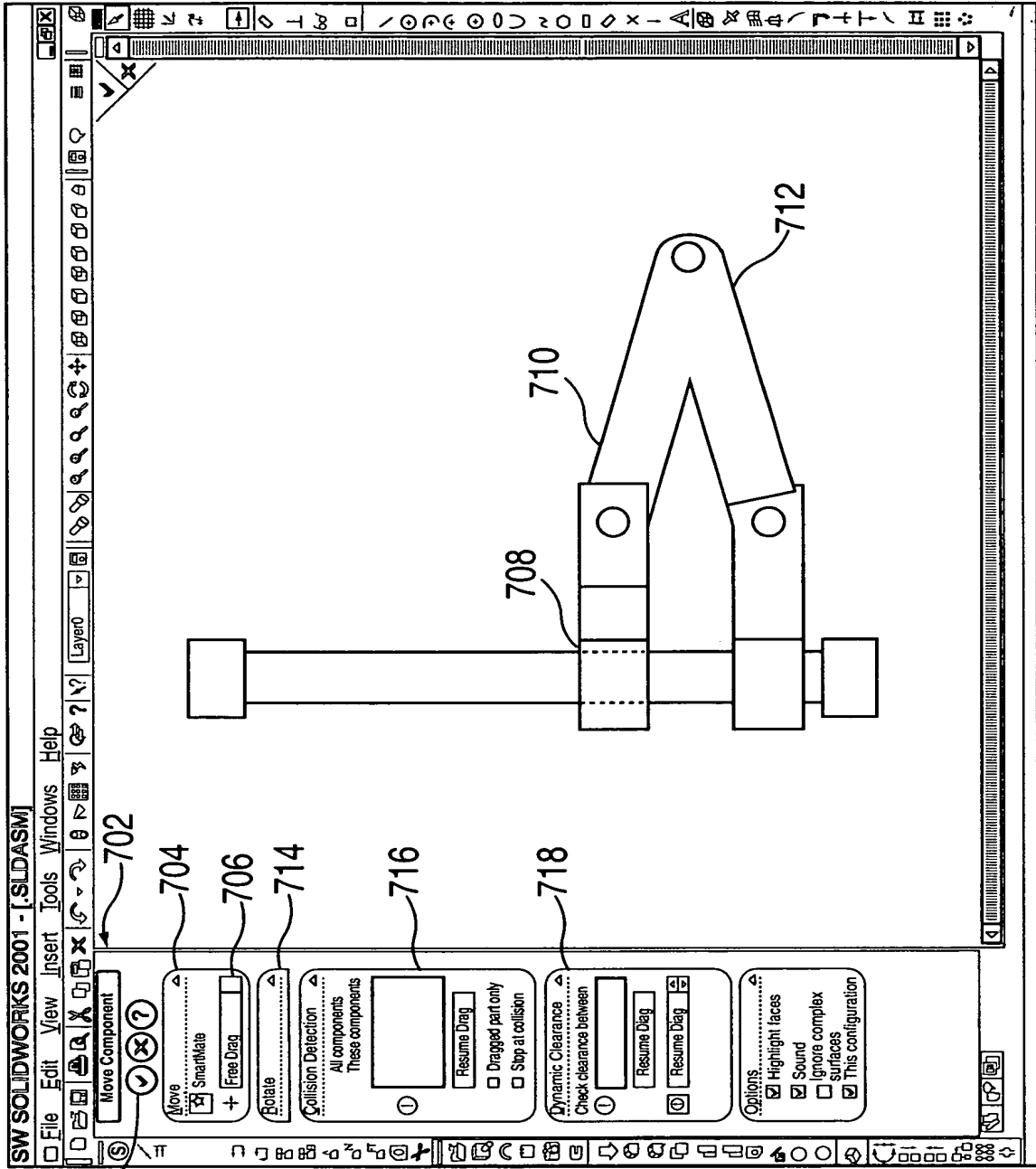

FIG. 7

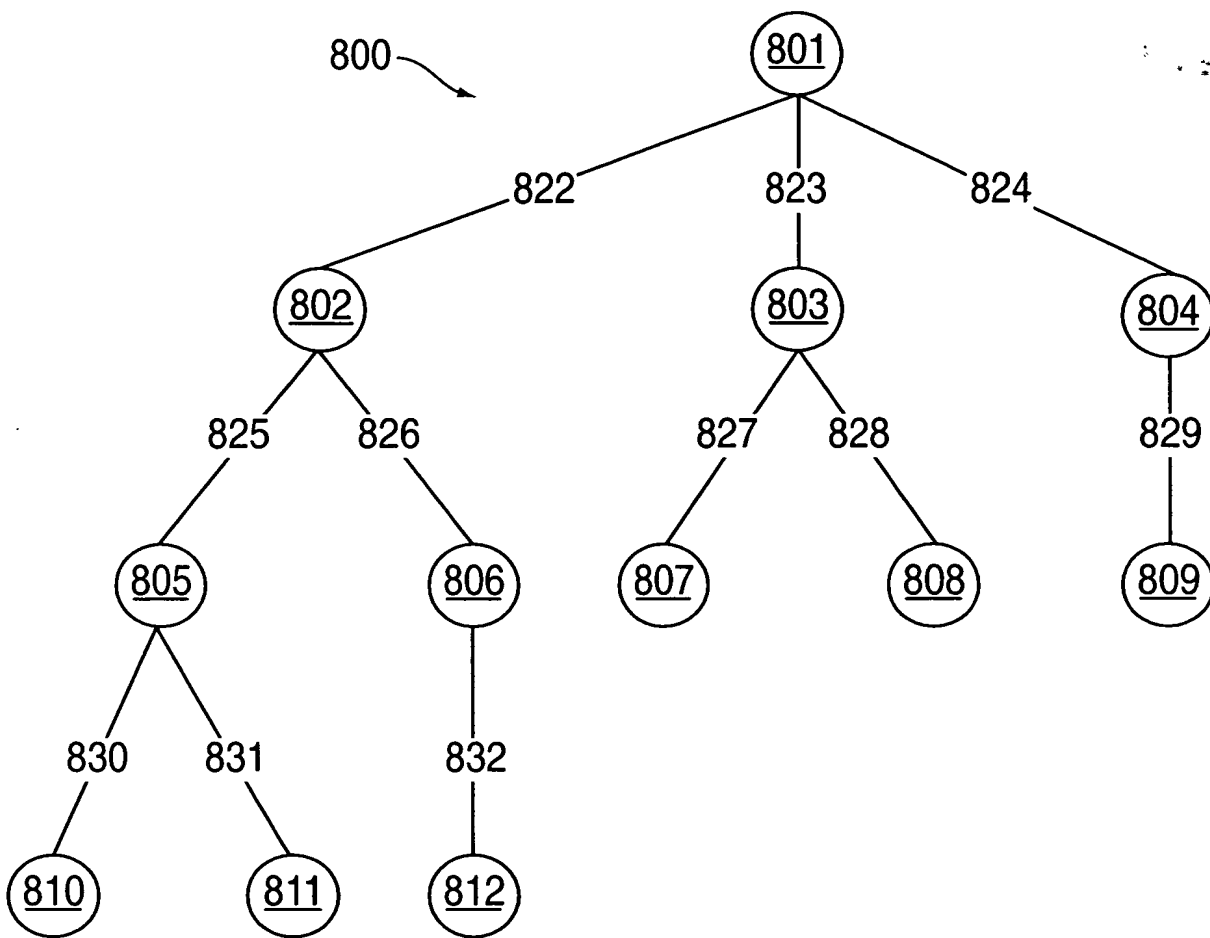

FIG. 8

0924294-120301

FIG. 8
CLASS

900 →

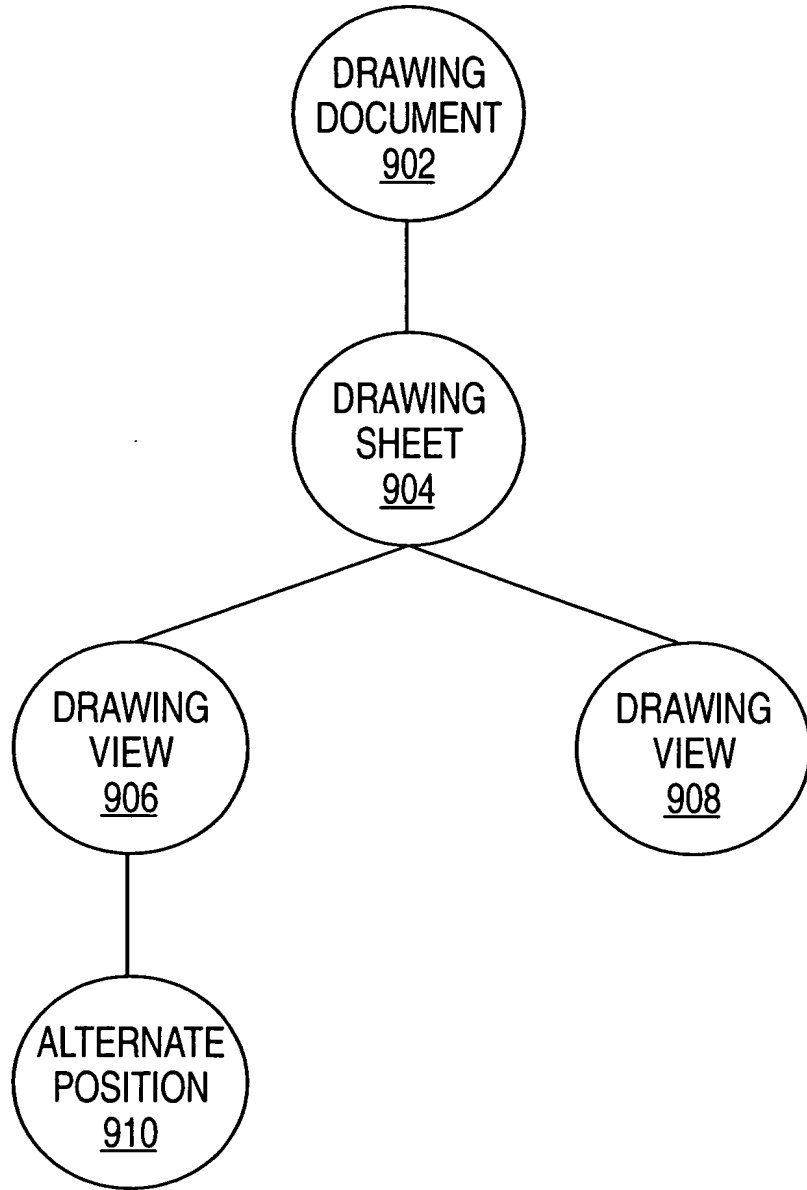

FIG. 9

0924294 120301

FIG. 9
SUBFIG.

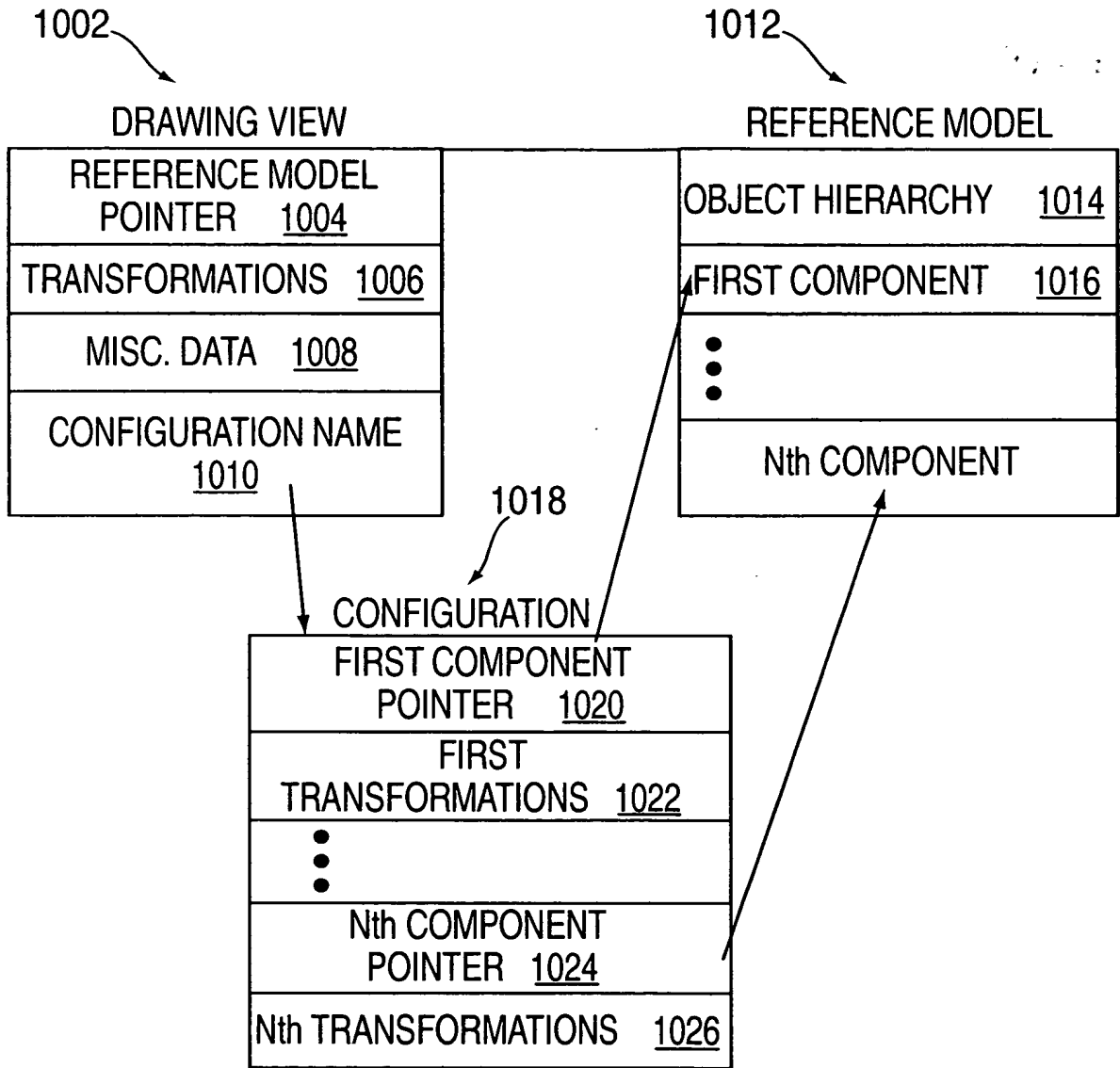
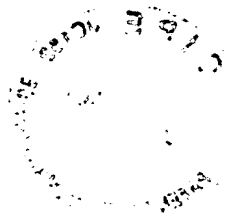
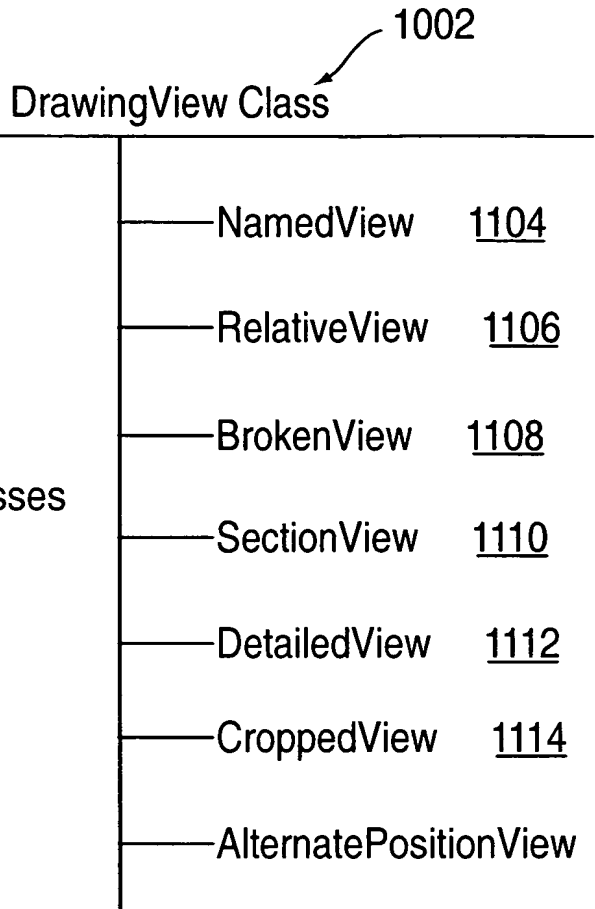

FIG. 10

0924294-12001



FOR "Hatched"

FIG. 11

FIG. 12

12/15

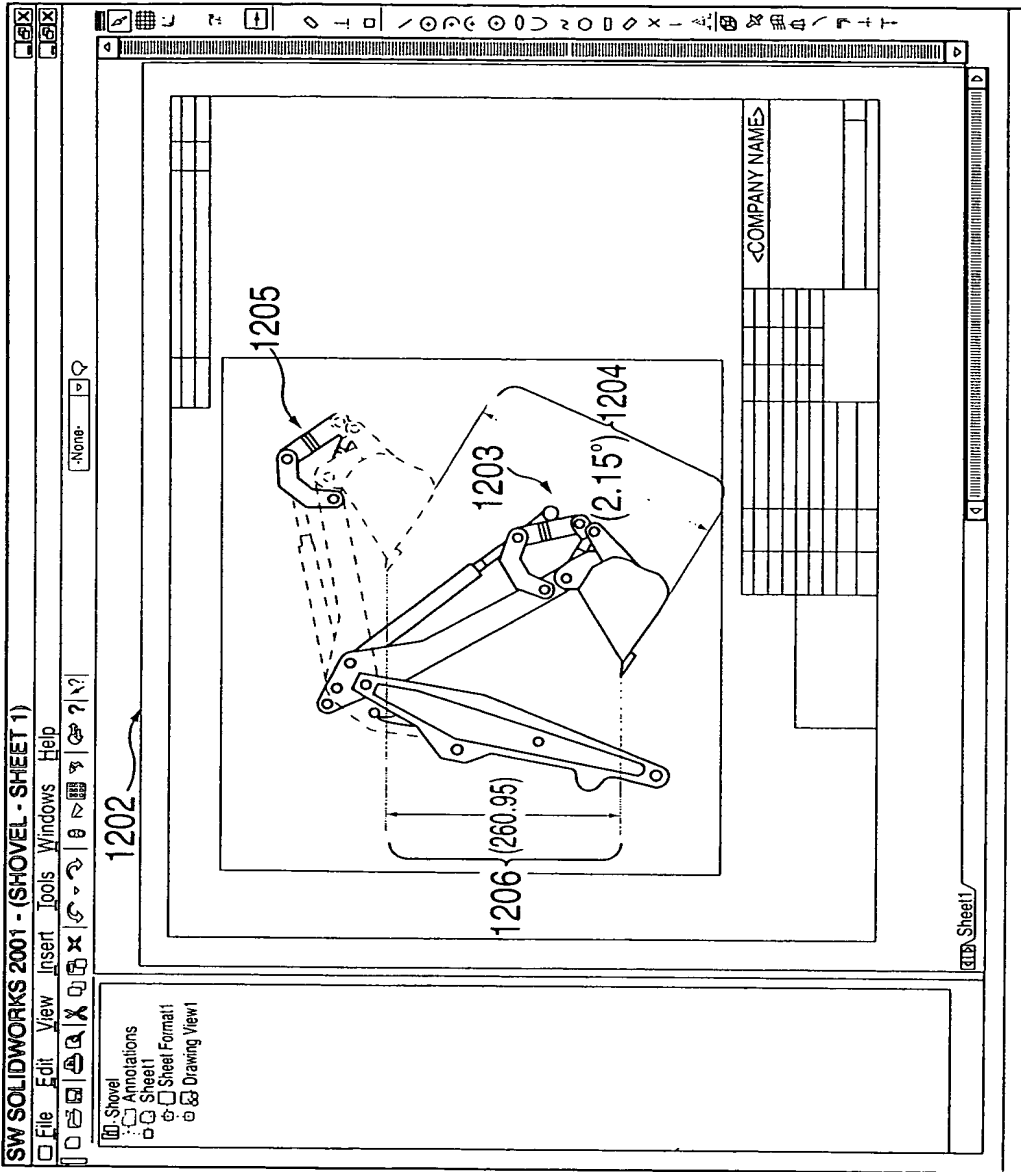
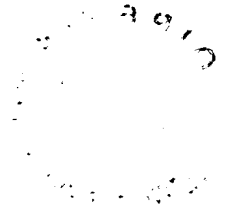

FIG. 12



1302

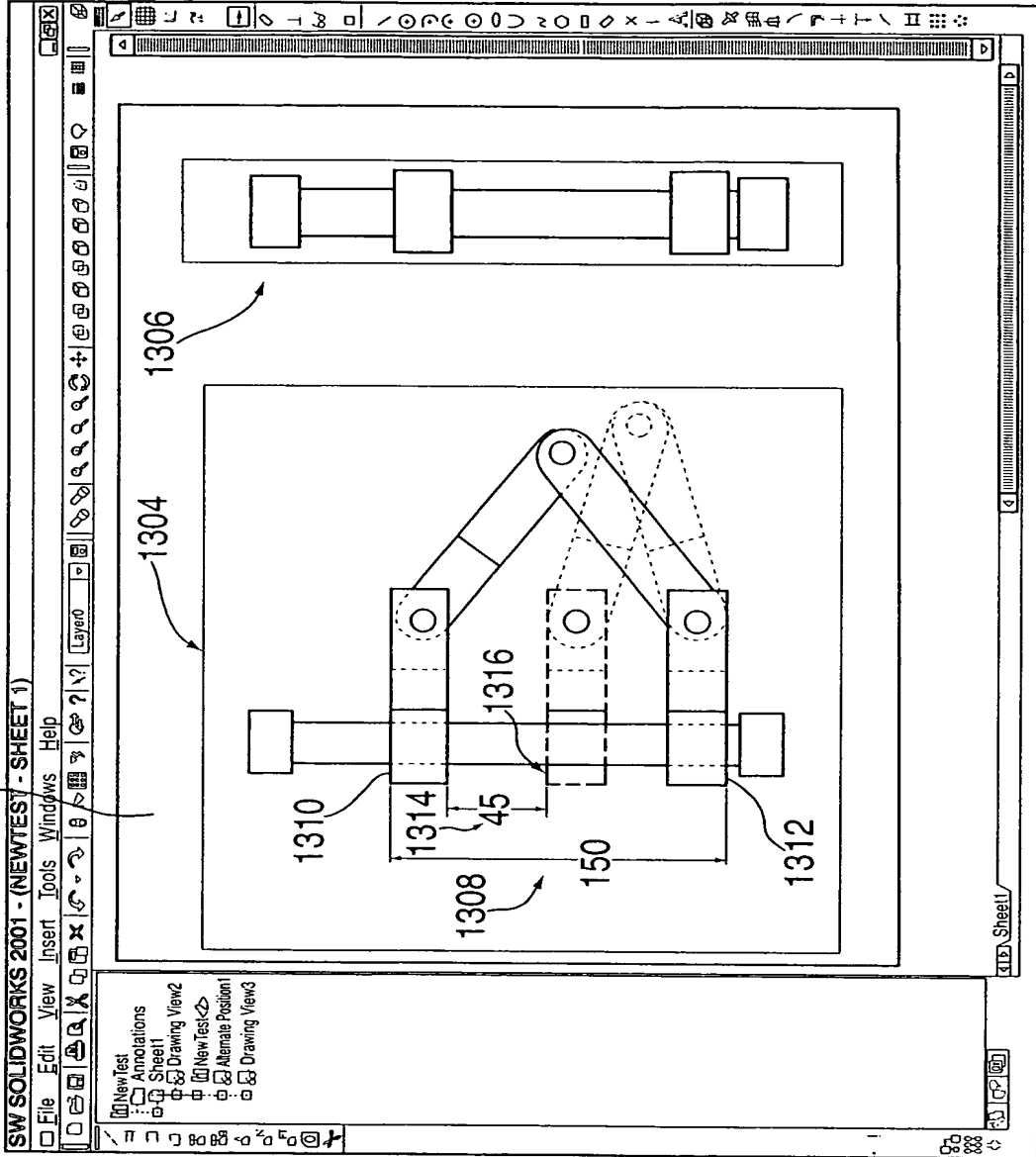

FIG. 13

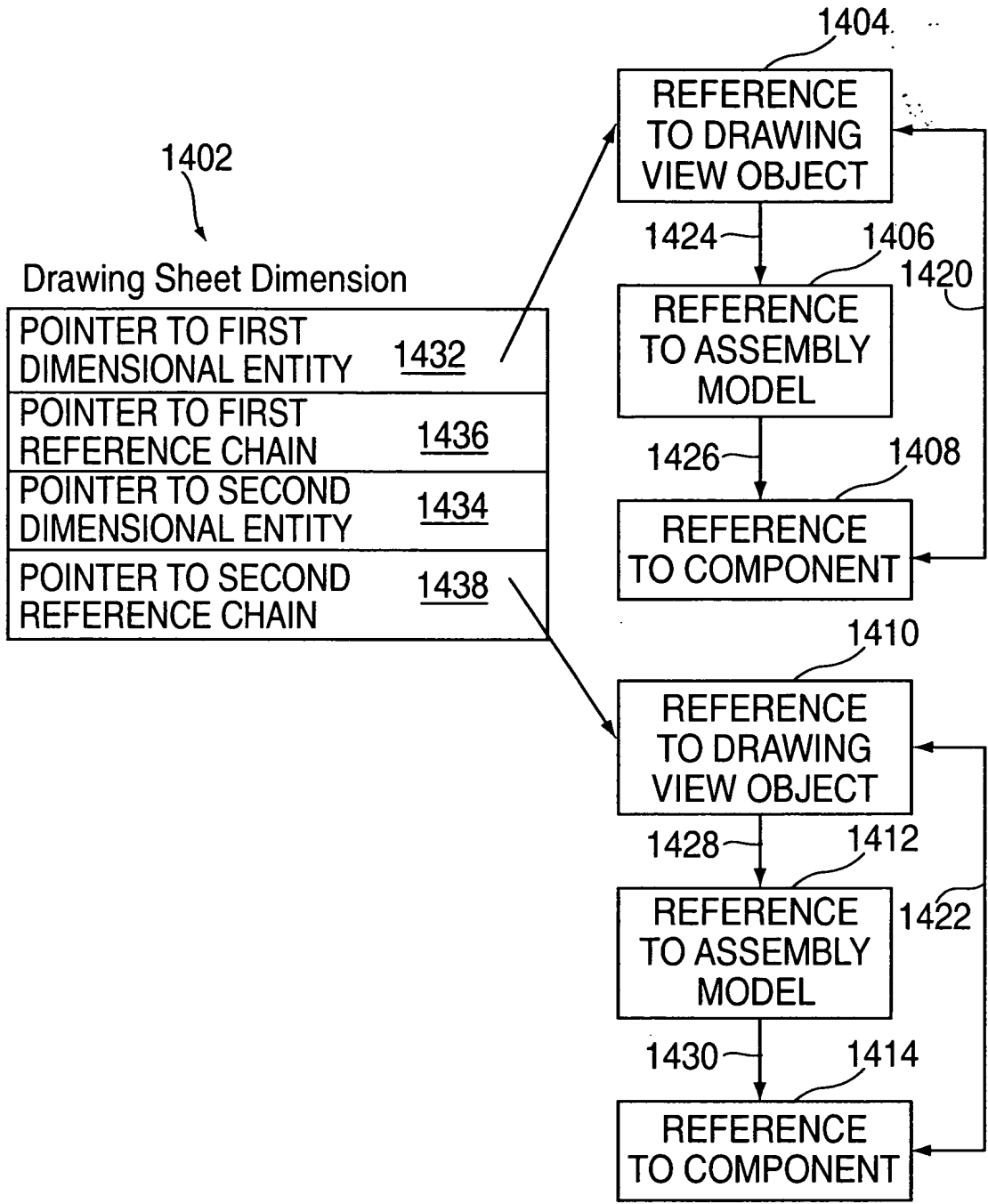

FIG. 14

09924294-10001

FIG. 15

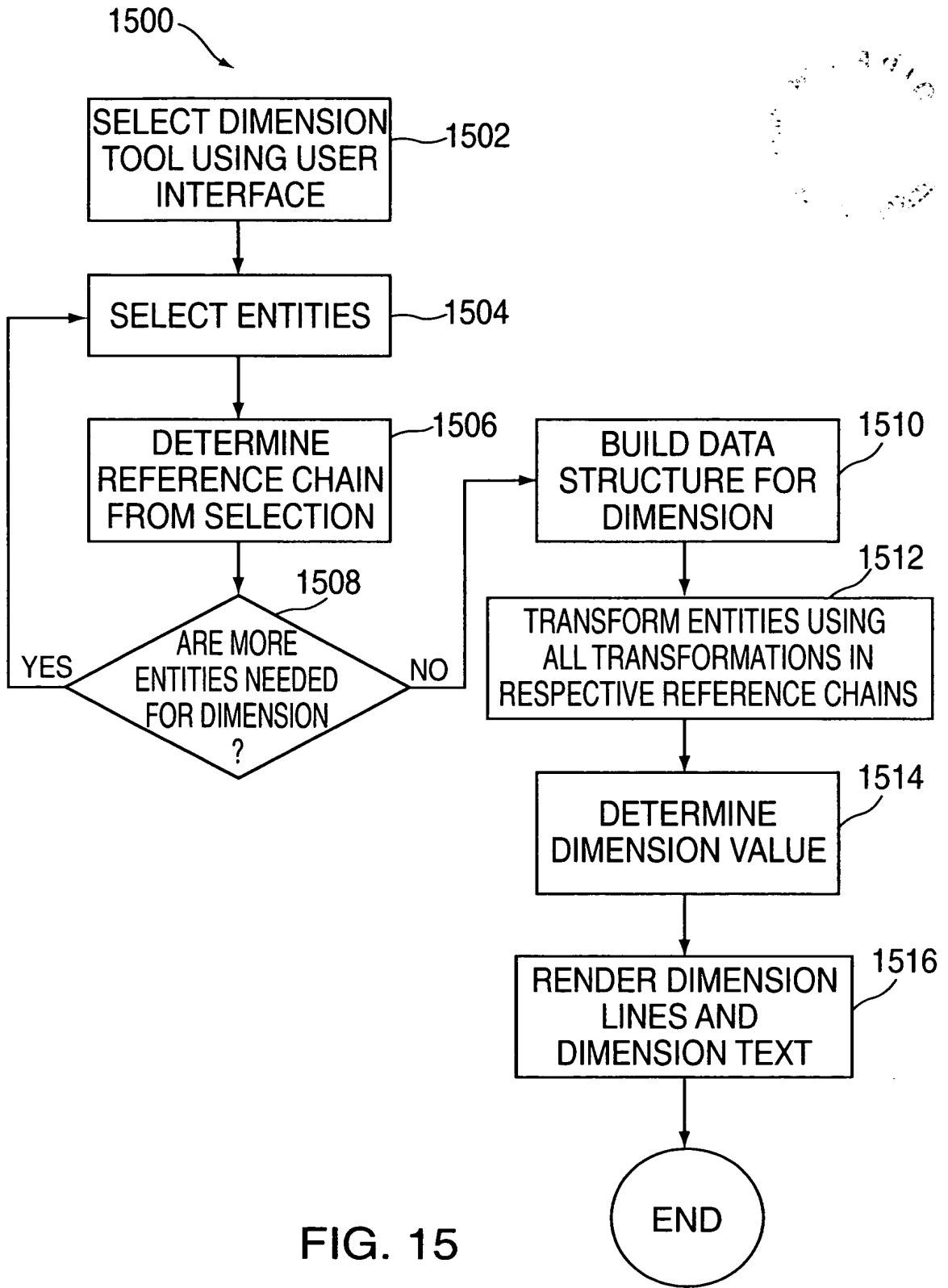

FIG. 15